

# DIESEL GENERATORS USER S GUIDE & MAINTENANCE MANUAL

**Power**san  
*Systems Of Power*



**PLEASE READ THIS MANUAL BEFORE INSTALLATION AND OPERATION**

<b>1. CONTENTS</b>	
<b>1. Contents</b>	<b>1</b>
<b>2. Preamble</b>	<b>4</b>
<b>2.1. Introduction</b>	<b>4</b>
2.1.1 General recommendations	4
2.1.2. Structure of the reference material	5
2.1.2.1 Level A	5
2.1.2.2 Level B	5
2.1.2.3 Level C	6
<b>2.2. Pictograms and their meanings</b>	<b>7</b>
<b>2.3. Safety instructions and regulations</b>	<b>9</b>
2.3.1 General advice	9
2.3.2 Risks related to feed gas (concerns gas sets)	11
2.3.3 Risks related to exhaust gases and fuels	11
2.3.4 Risks related to toxic products	12
2.3.5 Risk of fire, burns and explosion	12
2.3.6 Risks related to electrical networks	13
2.3.7 Dangers presented by electric currents (first aid)	14
2.3.8 Risks related to moving the set	14
2.3.9 Recommendation for the operator and environment	15
<b>3. Installation</b>	<b>17</b>
<b>3.1. Unloading</b>	<b>17</b>
3.1.1 Safety during unloading	17
3.1.2 Example of material	17
3.1.3 Instructions for unloading	17
3.1.3.1 Slings	17
3.1.3.2 Fork lift truck	18
<b>3.2 Handling instructions</b>	<b>18</b>
<b>3.3 Installation of fixed sets</b>	<b>20</b>
3.3.1 Position	21
3.3.2 Measurements and layout	21
3.3.2.1 Static requirements	21
3.3.2.2 Dynamic requirements	22
3.3.2.3 Construction	22
3.3.2.4 Base of the set	22
3.3.2.5 Openings	23
3.3.2.6 Lifting	23
3.3.2.7 Soundproofing	23
3.3.2.8 Ventilation	24
3.3.2.9 Fuel	25
3.3.2.10 Burnt gas exhaust	26
3.3.2.11 Electricity	29
3.3.2.12 Cooling	30
3.3.2.13 Special arrangements	31

4. Installation of mobile site sets.....	32
4.1 General information.....	32
4.2 Specific arrangements.....	32
5. Road trailer.....	33
5.1 Trailer linkage.....	33
5.2 Check before towing.....	34
5.3 Driving.....	34
5.4 Unhitching the trailer.....	34
5.5 Implementation for installation.....	35
6. Installation of electrical generating sets in containers.....	36
6.1 Handling, transport and positioning of the containers.....	36
6.1.1 Handling instructions.....	36
6.1.2 Transport.....	38
6.1.3 Installation - positioning.....	39
6.2 Maintenance.....	41
7. Preparation before operating the set.....	42
7.1 Installation checks.....	42
7.2. Connection checks.....	42
7.3 Starting the generating set.....	42
7.4 Load test on installation.....	42
8. Battery maintenance.....	43

## 8. BATTERY MAINTENANCE

### WARNING – DANGER

- install the battery so that it has the correct ventilation
- never place the battery close to a flame or fire
- use only insulated tools
- never use sulphuric acid or acid water to top up the electrolyte level.

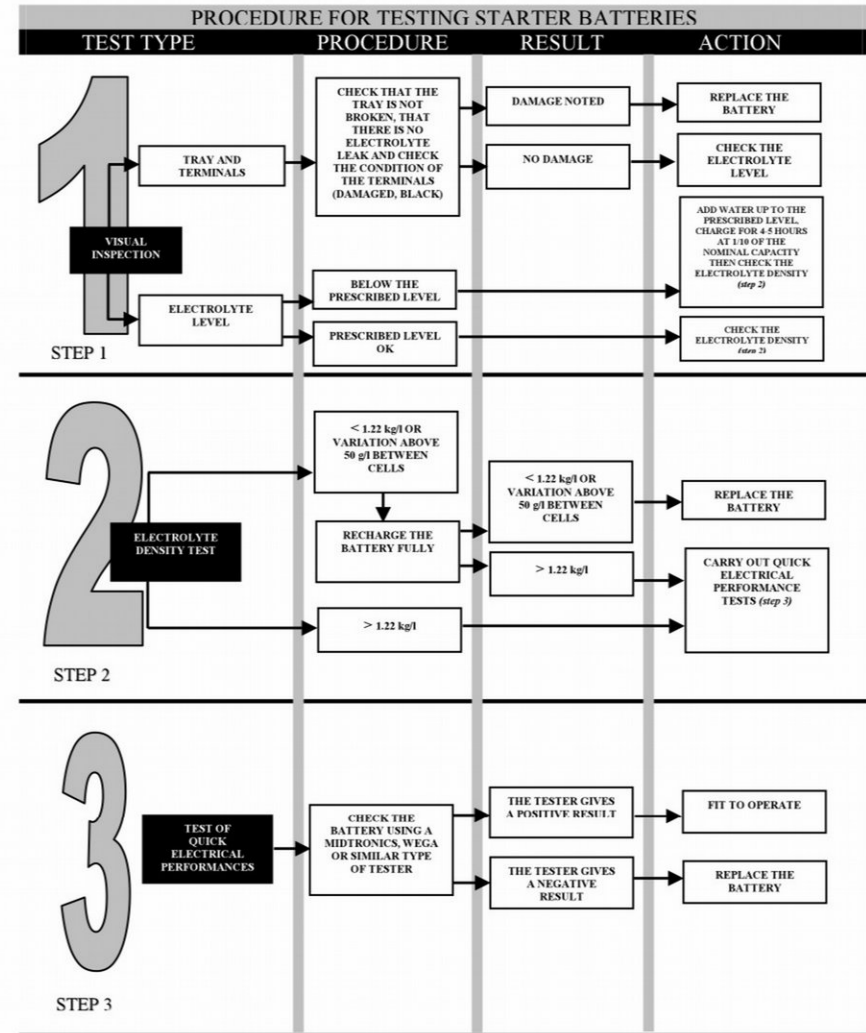

## 7. PREPARATION BEFORE OPERATING THE SET

### **WARNING – DANGER**

The inspections referred to in this section enable the electrical generating set to operate. Specific skills are required to carry out these operations. They must only be entrusted to personnel with the necessary skills. Failure to follow these instructions in any way could lead to incidents or very serious accidents.

### **7.1 Installation checks**

- check that the general recommendations from the installation section (ventilation, exhaust, fluids etc.) are followed
- check the levels (oil, water, diesel, battery).

### **7.2. Connection checks**

- check the remote controls by section and number (sector, accessories, low voltage central control panels etc.)
- apply voltage to the accessories to check the following components (non comprehensive list) :
  - fuel pump (consumption and direction of rotation)
  - water preheating (intensity and voltage)
  - battery charger
  - etc.

### **7.3 Starting the generating set**

- carry out the mechanical checks (oil pressure, water temperature, absence of noise etc.)
- carry out the electrical checks (voltage and frequency)
- carry out the safety checks (emergency stop, oil pressure, water temperature etc.)

### **7.4 Load test on installation**

- check the rotary field
- check the voltage, frequency and intensity
- check normal/emergency switching or coupling.

### Attached documents

User manual for the control unit, if fitted (level A)  
User and maintenance manual for the engine (level A)  
User and maintenance manual and spare parts catalogue for the alternator (level A)  
Wiring diagrams (supplied with the reference material or with the electrical generating set) (Level A)  
Engine spare parts catalogue (level B)  
Workshop manual (repair) for the engine (level C)

## 2. PREAMBLE

### 2.1. Introduction

#### 2.1.1 General recommendations

Thank you for choosing an electrical generating set from our company.

This manual has been designed to help you operate and maintain your electrical generating set correctly.

Read the safety instructions carefully in order to prevent any accident, incident or damage. These instructions must always be followed.

In order to obtain optimum efficiency and the longest possible life for the electrical generating sets, maintenance operations must be carried out according to the periods indicated in the attached preventative maintenance tables.

If the electrical generating set is used under dusty or unfavourable conditions, some of these periods will be shorter.

Ensure that all adjustments and repairs are carried out by personnel who have received the appropriate training. The dealers are suitably qualified and can answer all of your questions. They can also supply you with spare parts and other services.

The left and right sides can be seen from the back of the electrical generating set (the radiator is at the front).

Our electrical generating sets have been designed so that damaged or worn parts can be replaced by new or reconditioned parts thereby reducing the out of action period to a minimum.

For all parts replacement, contact your nearest dealer representing our company who will have the necessary equipment and properly trained and informed staff to carry out maintenance, parts replacement and even total reconditioning of generating sets.

Contact your local dealer for the available repair manuals and to make the necessary arrangements for training personnel in implementation and maintenance.

#### **IMPORTANT**

Some user manuals and maintenance manuals for the engines fitted to the electrical generator assemblies include information on the control units and detail the engine starting and stopping procedures.

As the electric generator assemblies are fitted with assembly-specific test and control panels, only the information in the documentation regarding the panels fitted to the assemblies should be taken into consideration.

## 6.2 Maintenance

- lubricate the hinges and locks regularly
- lubricate the joints with silicone grease
- wash and clean the bodywork using products designed for car bodywork
- check the condition of the bodywork and retouch any scratches straight away (to prevent the start of corrosion).

The environmental impact should also be analysed so that the disturbances to be caused by the equipment will not affect those living close by.

Therefore, it is essential to be aware of the regulations in force, in order not to be vulnerable to future legal action.

On this subject, the sound level of the set and reverberation effects on buildings must be taken into account .

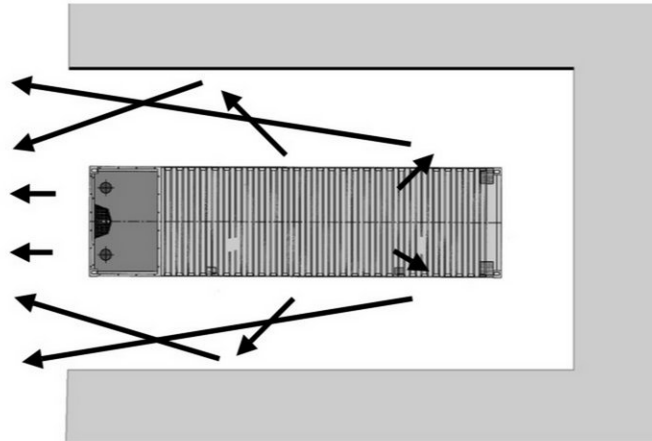

Examples of increases in noise level due to reverberation and positioning.

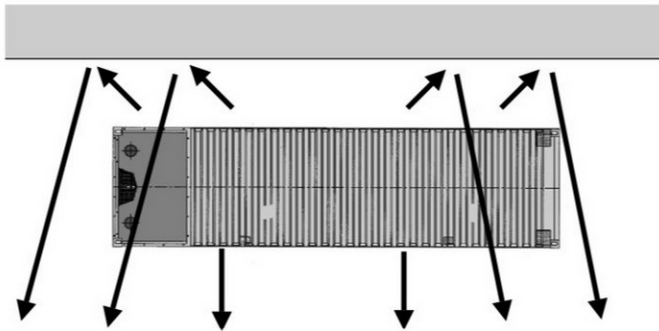

The equipment should also be installed so that the vents controlling the air intake should be opposite so that there are no difficulties in difficult weather conditions (intake of air, snow, sand etc.).

## 2.1.2. Structure of the reference material

The reference material delivered with the generating sets is divided into 3 levels:

### 2.1.2.1 Level A

This basic level gives all the user and maintenance procedures for the generating set or power station.

This reference material enables you to get to know the equipment, operate it and maintain it, both on a daily basis and periodically.

The reference material for the engines and alternators fitted to the sets consists of engine user and maintenance manuals (from the manufacturer) and alternator user and maintenance manuals (from the manufacturer).

Level A reference material contains:

- the user and maintenance manual, containing among other things:
  - o general recommendations and safety regulations to be adhered to general recommendations for installing generating sets
  - o general instructions for preparing generating sets before putting them into operation
  - o Tables of capacities (lubricants and coolants) and fuel tanks of different engines that may be fitted to the sets according to their configurations (covered or not)
  - o general reference material for maintaining starter batteries
- user and maintenance manual for the engine fitted to the set
- maintenance manual for the alternator fitted to the set
- user manual for the control panel (if fitted)
- wiring diagrams (these diagrams are supplied with the reference material or delivered with the generating set)

### 2.1.2.2 Level B

This reference material is additional to the level A reference material.

In addition, it contains the spare parts catalogue for the engine fitted to the set, and enables a qualified user to identify a part and order it.

#### Composition

List (index mark, description, part number etc.)

Illustrations (index mark).

**These parts catalogues are only available in English regardless of the engine manufacturer.**

### 2.1.2.3 Level C

This reference material is additional to the level B reference material.  
It contains the information required for major maintenance of the generating set or power station (workshop/repair manual)  
This document enables an experienced user to carry out repairs to equipment following deterioration or damage.

#### Composition

Illustrated text (index mark, commentary, procedure, intervention period, required level etc.)  
Tools list.  
**This reference material exists mainly in English regardless of the engine manufacturer.**

### 6.1.3 Installation - positioning

The position should first be considered in relation to the electricity distribution centre, fuel storage, the general environment and type of ground before the equipment can be accommodated.

The installation area should be flat enough for the frame to rest level on it and strong enough so that the container does not sink down.

If the container(s) are being installed definitively, a concrete foundation must be constructed, for which the calculations and execution must be performed by a specialist .

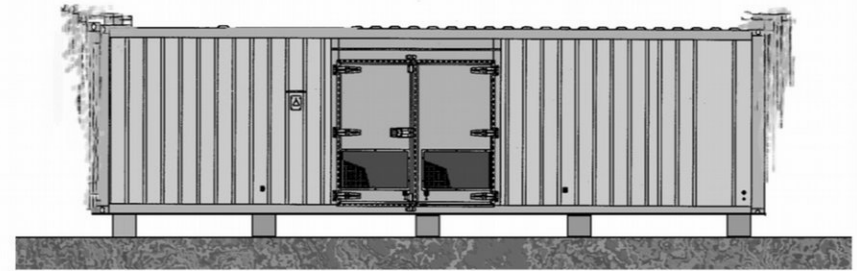

NO

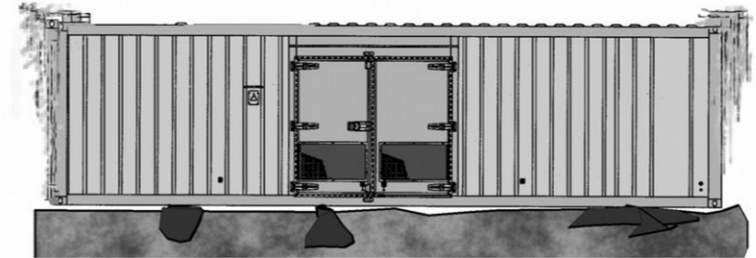

NO

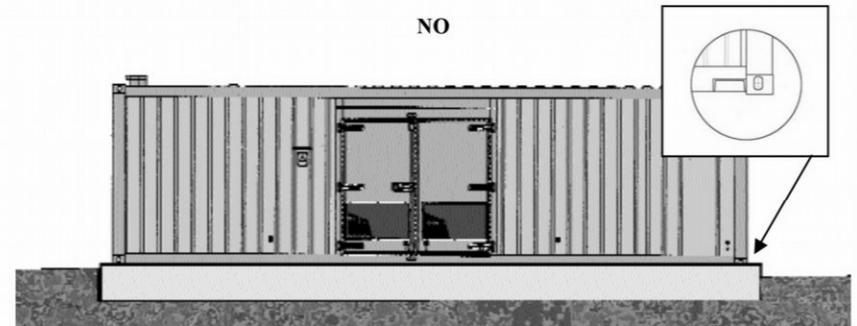

YES

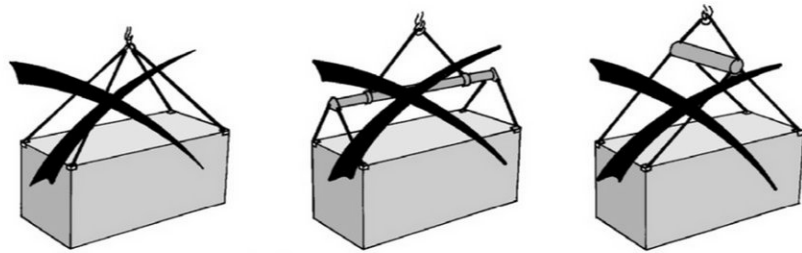

Example of a lifting method not to be used

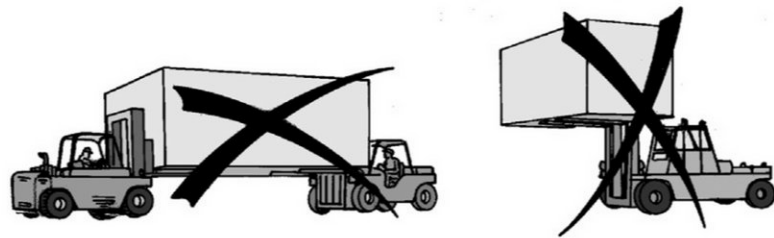

Example of a handling method not to be used

### 6.1.2 Transport

The transport of containers should be in accordance with the highway code (for the relevant countries).

The transport equipment (trailer, semi-trailer, container holder etc.) should be suitable for this use and provide all safety guarantees in terms of its capacity to support the load and the attachment devices.

Driving should be on vehicular roads of sufficient quality not to damage the equipment stored inside the container.

#### **WARNING**

Although they look very like ISO transport containers, our equipment does not comply with the different certification tests that these have undergone. Therefore our containers cannot carry additional loads (no stacking).

### 2.2. Pictograms and their meanings



Warning danger



Warning, risk of electric shock



Warning, toxic materials



Warning, pressurised liquids



Warning, high temperature, risk of burns



Warning, rotating or moving parts (risk of getting caught in the machinery)



Warning, corrosive product



Publications delivered with the generating set must be referred to



Protective clothing must be worn



Your eyes and ears must be protected



Periodic maintenance must be carried out



Battery level must be checked



Lifting point required



Stacking point required



Warning, risk of explosion



Naked flames and unprotected lights prohibited. No smoking



Entry prohibited to non-authorised persons



Exinction by water prohibited



Power



When on a trailer, earth the set before starting it



Earth



Emergency cut-out

Application of EU Machine Directive 98/37 of 22 June 1998 in relation to generating sets.

- access restricted to authorised personnel only according to the legislation in force
- live installation: possible automatic start-up.

### Examples of equipment and handling



Example of container lifting using a lifting beam fitted with hooks, shackles or manually coupled locks.

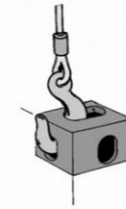

Example of grip by an ordinary hook

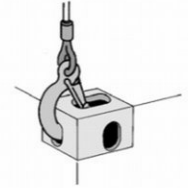

Example of grip by a safety hook

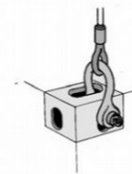

Example of shackle grip

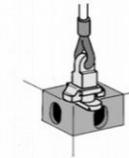

Example of grip by a manually coupled lock

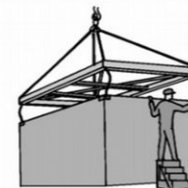

Attachment of lifting device

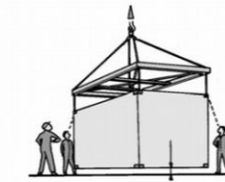

Checking the attachment when the container is still on the ground

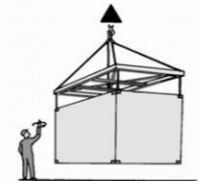

lifting

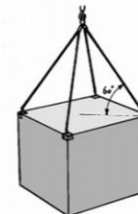

Example of lifting

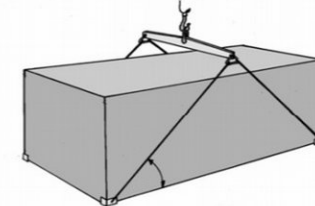

Example of a container lifted by four parts in the bottom corners

## 6. INSTALLATION OF ELECTRICAL GENERATING SETS IN CONTAINERS

### WARNING

When the generating set is working in **automatic** start mode, the air evacuation doors must be open.

### WARNING

When the generating set is working in **manual** start mode, the air evacuation doors must be open before it starts.

### WARNING DANGER

When the generating set has been started and the doors have remained closed, they are **formally** prohibited from being opened (very severe risk of injury owing to sudden opening of doors).

### WARNING

Before beginning handling procedures, you must ensure that the operating personnel has the necessary qualifications. All handling procedures must be carried out under the instruction of one co-ordinator only.

It is essential to use an adapted lifting vehicle (lifting and travel limit, etc.) fitted with a lifting beam to ensure that the container is moved correctly.

## 6.1 Handling, transport and positioning of the containers

### 6.1.1 Handling instructions

- attach the lifting vehicle slings to the handling rings on the container .
- carefully stretch the slings without lifting the container.
- check that the sling hooks are correctly attached and the equipment is solid.
- lift the container carefully and without jerking
- direct and stabilise the container towards its final position.
- position the container, while still lifted, in accordance with its final position.
- carefully set down the container without jerking while continuing to position it.
- once the container is on the ground and in the correct position, release the slings, check that the container is stable and correct it if not
- detach the slings and remove them from the lifting rings.
- the procedure has been completed when the container is in position.

## 2.3. Safety instructions and regulations

### THESE SAFETY PRECAUTIONS ARE IMPORTANT

If you do not understand or have any questions about any point in this manual, contact your dealer who will explain it to you or give you a demonstration. A list of risks and precautionary measures to take follows. You should also refer to any local and national regulations that apply in accordance with your own jurisdiction.

### 2.3.1 General advice

- Read and understand the manuals provided with the generating set in full.
- Do not wear loose clothing and do not go near the machines when operating. Note that the fans are not clearly visible when the engine is running.
- Warn all people present to keep well back during operation.
- 
- The generating set should always be controlled by an experienced person.
- Always test the generating set from the control panel.
- Follow the maintenance table and its directions.
- Never let anyone else use the generating set without having first given them the necessary instructions.
- Do not run the engine without having refitted the protective covers.
- Engine with turbocharger: never start the engine without fitting the air filter. The rotating compressor wheel in the turbocharger can cause severe physical injury. Foreign objects in the intake duct can cause mechanical damage.
- Engine with air preheating (starter components): never use starter aerosol or similar product as starter assistance.  
When it comes into contact with the starter component, an explosion may occur in the inlet manifold and lead to physical injury.
- Never let a child touch the generating set, even when not in use. Avoid using the generating set in the presence of animals (can distress the animal).
- Never start the engine without an air filter or exhaust.
- Always follow current local regulations regarding generating sets and use of fuel (petrol and gas) before using your generating set.
- Never use sea water or any other electrolytic or corrosive product in the coolant circuit.



- Disconnect the battery and pneumatic starter (if there is one) before carrying out any repair, to prevent the engine from starting accidentally. Fit a panel over the controls to prevent any attempt at starting.
- Do not modify the engine.
- Only use the correct techniques for turning the crankshaft to rotate the crankshaft manually. Do not try to rotate the crankshaft by pulling or exerting force on the lever on the fan. This method can cause serious physical or material harm or damage the fan blade (s), leading to premature breakdown of the fan.
- Always use tools in good condition. Check that you have understood how to use them before starting a procedure.
- Only fit original spare parts.
- Use tools that correspond to the work being carried out.
- Clean all traces of oil or coolant with a clean cloth.
- Never use petrol or other flammable substances to clean parts. Use only approved cleaning solvents.
- Do not use a high-pressure cleaner for cleaning the engine and fittings. The radiator, hoses, electrical components etc. could be damaged.
- Avoid accidental contact with parts that reach high temperatures (exhaust manifold, exhaust)
- Engage the parking brake when the generating set on its trailer is installed on the operating site.
- When setting on a slope; check that no-one is behind the trailer.
- Protective eyewear must be worn when handling during maintenance operations. Operators should remove watches, chains, etc.

### **5.5 Implementation for installation**

Procedures to be carried out:

- check that the ground is strong enough for the assembly not to sink into it
- using the front wheel, position the set as horizontally as possible
- engage the handbrake.
- lower the rear trailer supports and lock them

## **5.2 Check before towing**

Before towing carry out the following checks:

- wheel torquing
- lock trailer hook
- tyre pressure
- light signals working
- cover doors closed
- parking brake off
- front wheels and rear supports lifted.
- tightening and fixing the draw bar arms locking levers
- brake test for "road" type trailers
- fitting brake safety cable.

## **5.3 Driving**

- "On-site" type trailer

These trailers are not fitted with a main brake and so cannot brake when operating; the tyres are designed for a speed of 17 mph (27 Km/h). Therefore, it is absolutely forbidden to exceed this speed .

- "Road" type trailer

The driving speed should be adapted to road conditions and the trailer handling.

Driving at sustained speed causes tyres to heat up; therefore it is important to stop from time to time to check them. Excessive heating can lead to a blow out and hence a serious accident. When reversing, do not forget to lock the overrun brake.

### **NOTE**

Particular attention must be paid to wheel torquing on new vehicles. Indeed, during the first few miles, heat build-ups on the wheel hubs and brake drums lead to reduced wheel torquing. It is therefore essential to check the torquing every 6 miles (10 kilometres) until no further loosening is noted.

The torque test should nevertheless be carried out before towing.

## **5.4 Unhitching the trailer**

This operation should be carried out on horizontal, flat, stable ground.

- lock the wheels
- lower the front wheel
- disconnect the road signals wire
- refit the hitch using the wheel to release the hook ring from the tow vehicle,
- release the tow vehicle
- engage the handbrake.

## **2.3.2 Risks related to feed gas (concerns gas sets)**

### **WARNING – DANGER**

The gas is explosive. It is forbidden to smoke, go near or create sparks when the tank is being filled and near to the generating set.

- Request the user technical notes and LPG or NG safety data sheets from your gas supplier. ■
- Gas installations must be installed, maintained and repaired by recognised specialists.
- Do not attempt to open, unseal or intervene in gas supply pressure relief valves and on the gas line in general. ■
- Gas supply procedures must be carried out in fresh air (outside) in accordance with local regulations, in an area well away from fire, people or animals.

## **2.3.3 Risks related to exhaust gases and fuels**

### **WARNING - DANGER**

generating sets should not be operated in unventilated areas.

- Always follow the local regulations in force regarding generating sets and use of fuel (petrol, diesel and gas) before using your generating set.
- Fuel filling should be carried out when the engine is stopped (except for sets with an automatic filling system)
- Engine exhaust gases are toxic: Do not operate the generating set in non ventilated areas. When installed in a ventilated area, the additional requirements for protection against fire and explosions must be observed.
- If a burnt gas exhaust leaks, the generating set may become more noisy. In order to be sure of its efficiency, you should periodically examine the burnt gas exhaust.
- Pipes must be replaced as soon as their condition requires it.

### 2.3.4 Risks related to toxic products

#### WARNING – DANGER

The corrosion inhibitor contains alkali. This substance should not come into contact with the eyes. Avoid any prolonged or repeated contact with skin. It should not be swallowed. In the event of skin contact, wash thoroughly with water and soap. In the event of contact with eyes, rinse immediately with plenty of water for at least 15 minutes. CALL A DOCTOR IMMEDIATELY. KEEP THE PRODUCT OUT OF THE REACH OF CHILDREN.

The anti-rust product is toxic and dangerous if absorbed. Avoid any contact with skin or eyes. Read the instructions on the packaging.

Glycol is a toxic product and dangerous if absorbed. Avoid any contact with skin or eyes. Read the instructions on the packaging.

- Never expose the equipment to liquid splashes or rainfall, and do not place it on wet ground.
- Always use the recommended fuels. Using low quality fuels risks damaging the engine and altering performance
- The battery electrolyte is harmful to skin and especially eyes. If splashes get into eyes, rinse immediately with running water and/or a 10% diluted boric acid solution.
- Wear protective eyewear and strong base resistant gloves for handling the electrolyte .

### 2.3.5 Risk of fire, burns and explosion

#### WARNING – DANGER

The engine should not be operated in areas containing explosive products. There is a risk of sparks forming where all electrical and mechanical components are not shielded.

- Beware of creating sparks or flames and do not smoke near batteries as the electrolyte gases are highly flammable (especially when the battery is being filled). Their acid is also harmful to the skin and particularly the eyes.
- Never clean, lubricate or adjust an engine when it is in operation ( unless you are qualified to do so, in which case extreme care must be taken to avoid accidents)
- Never make adjustments that you are not familiar with.
- Never cover the generating set with any material while it is working or just after it stops (wait until the engine has cooled)
- Do not touch hot components such as the exhaust pipe and do not put combustible material on them.
- Keep all flammable or explosive products (petrol, oil, cloth, etc.) well away when the set is running.

## 5. ROAD TRAILER

### 5.1 Trailer linkage

Before attaching the trailer, check the trailer hook on the tow vehicle; it should fit the trailer ring perfectly.

#### WARNING – DANGER

Trying to tow a trailer with a non-matching device (bar, wires, cords, etc.) could lead to serious accidents.

Also check:

- no incipient fractures or excessive wear on the hitching system.
- locking system is operating properly

To hitch the trailer, proceed as follows:

- lock the wheels to stop the trailer from moving
- lift up the rear trailer supports and lock them
- release the parking brake
- release the locking levers for the draw bar arms and adjust the ring to the same height as the vehicle hook
- hitch the trailer, remove the locks on each side of the wheels then lift up the front wheel fully using its handle
- connect the electrical circuit of the trailer to that of the tow vehicle
- hook the handbrake safety wire onto the hook on the tow vehicle.

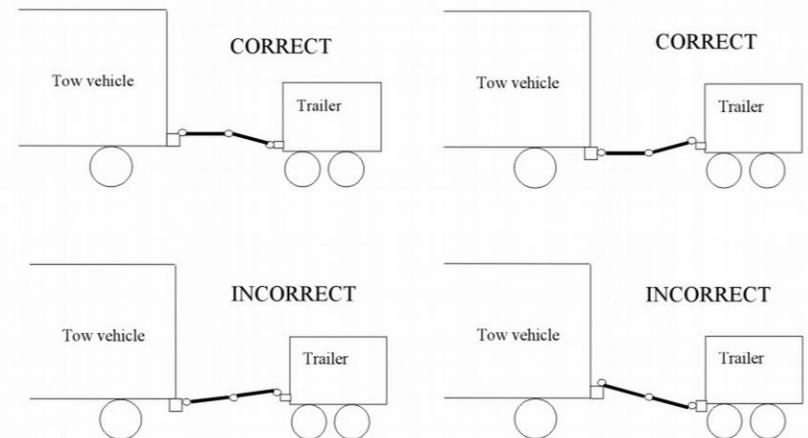

#### 4. INSTALLATION OF MOBILE SITE SETS

##### 4.1 General information

Besides the advice and rules given for fixed sets, certain arrangements must be made for "site" sets.

##### 4.2 Specific arrangements

An area will be reserved to install the generating set. Its should be flat and strong enough so that the generator does not sink into it. It could be made of concrete or even large planks fitted together.

It should be noted that a generating set that does not rest correctly on its base (frame or trailer) will be subject to vibrations that could cause damage to all the equipment.

The location of the set on site should be chosen for ease of fuel supply and distribution of current to the users.

Access to the set's doors should be available at all times for safety and maintenance reasons. Ventilation of the generating set should not be affected if there are different objects close by. It will cause abnormal heating and reduced power.

Burnt gas evacuation will take place in such a way that there is no reaspiration into the air filter or cooling system.

The generating set's neutral speed must be used to protect people.

Earthing is carried out using a metal post buried deeply in the ground.

These sets are to be covered or protected from bad weather by a suitable construction (see previous sections).

- Good ventilation is required for your generating set to work properly. Without ventilation, the engine will quickly reach an excessive temperature that could lead to accidents or damage to the equipment and surrounding items.
- Do not take off the radiator cap when the engine is hot and the coolant is pressurised due to risk of burns.
- Depressurise the air, oil and coolant circuits, before removing or disconnecting any unions, ducts or connected components. Be aware of any possible pressure that might be present when disconnecting a device from a pressurised system. Do not look for pressure leaks manually. High pressure oil can cause physical accidents.
- Some preservative oils are flammable. Also, some are dangerous to inhale. Check that ventilation is good. Use a protective mask.
- Hot oil causes burns. Avoid contact with hot oil. Check that the system is no longer pressurised before carrying out any procedures. Never start or run the engine when the oil filling cap is off as oil may be ejected.
- Never start or run the engine when the oil filling cap is off as oil may be ejected.
- Never cover the generating set with a fine layer of oil for anti-rust protection.
- Never fill up the oil or coolant when the generating set is running or when the engine is hot.

##### 2.3.6 Risks related to electrical networks

- The electrical equipment supplied with the generating set complies with standard NF C15.100 or the standards of the relevant countries
- Read the manufacturer's identification plate carefully. The values for voltage, power, current and frequency are shown. Check that these values match the supply use.
- Never accidentally touch naked wires or disconnected connections.
- Never handle a generating set with wet hands or feet.
- Maintain electrical wires and connections in good condition. Using equipment in poor condition can lead to electrocution and damage to equipment.
- 
- Any procedure on the equipment must be carried out voltage free.
- Electrical connections must be made in accordance with current standards and regulations in the country.
- Do not use faulty, poorly insulated or provisionally connected wires.
- Do not invert the positive and negative terminals of batteries when connecting them. Such an inversion can lead to severe damage to the electrical equipment. Follow the wiring diagram supplied by the manufacturer.

- The generating set should not be connected to any other power sources, such as the public distribution network. In specific cases where there is a reserve connection to existing electrical networks, it must only be carried out by a qualified electrician, who should take the operating differences of the equipment into account, according to whether the public distribution network or generating set is being used.
- Protection against electric shocks is ensured by an assembly of specific equipment. If this needs to be replaced, it should be by components with identical nominal values and specifications.
- Due to strict mechanical specifications you should only use flexible resistant rubber sleeved wires, in compliance with CEI 245-4 or equivalent wires.

### 2.3.7 Dangers presented by electric currents (first aid)

#### First aid

In the event of an electric shock, cut off the voltage immediately and activate the set's emergency stop. If the voltage has not yet been cut off, move the victim out of contact with the live conductor as quickly as possible. Avoid direct contact both with the live conductor and the victim's body. Use a dry plank of wood, dry clothes or other non-conductive materials to move the victim away. The live wire may be cut with an axe. Take extreme care to avoid the electric arc that results from this.

#### Begin emergency procedures

#### Resuscitation

If breathing has stopped, begin artificial respiration at once in the same place the accident took place unless the victim or operator's life could be endangered by this.

In the event of cardiac arrest, carry out cardiac massage.

### 2.3.8 Risks related to moving the set

- Use lifting units to lift the generating set. Always make sure that the lifting equipment is in good condition and has a sufficient lifting capacity.
- In order to work in complete safety and prevent the components fitted to the top of the engine from being damaged, the engine should be lifted with an adjustable boom. All chains and cables should be parallel to one another and as perpendicular as possible to the top of the set.
- If other equipment fitted to the generating set alters its centre of gravity, special lifting devices may be required to maintain the correct balance for working in total safety.
- Never carry out work on a generating set that is suspended on a lifting device only.

#### c) Lost water exchanger

This type of cooling consumes a non negligible degree of water and hence there is an operating cost to be taken into account. This the solution when local provisions ensure the flow of water and do not allow the ventilation provisions to be made for cooling by a ventilated radiator or air recoler.

These lost water installations consist essentially of an exchanger, with one of its circuits fitted with an expansion receptacle, connected to the engine cooling circuit. The latter's water pump ensures circulation. The second exchanger circuit, known as raw water is connected between the building's water supply and the drain. A valve fitted upstream of the exchanger can enable and cut off circulation. With automatic sets, this valve should also come with an electric control (solenoid valve).

This system's heat exchange ensures engine cooling. The room needs a ventilations system and this type of installation requires a detailed study.

#### d) Ventilation of the room

Extractor fans and/or air blowers can evacuate heat radiation from the engine and supply fresh air to the room and equipment in the case of external air coolers or lost water exchangers. If fans are being used, more fans, rather than one large one, can regulate the temperature. Ventilation of the premises requires a detailed study and should take into account the atmospheric air temperature and loss of pressure of components located in the air inlet and outlet (grilles, sound traps etc.) in particular

### 3.3.2.13 Special arrangements

generating sets are not fitted with protection against power surges caused by drops in atmospheric pressure or manoeuvring.

The company does not accept any responsibility regarding damage caused by these occurrences.

However, lightning conductors can be installed, on the understanding that this does not give total protection.

#### b) Power cables

These can be unipolar or multipolar according to the power of the generating set.

Power cables should preferably be installed in ducts or on a cable tray for this purpose.

#### c) Battery cables

Install the battery or batteries immediately beside the electric starter motor. The wires will be connected directly from the battery terminals to the starter motor terminals.

The first instruction to follow is to check that the polarities of battery and starter motor correspond.

The minimum section of the wires is 70 mm<sup>2</sup>. It varies according to the power of the starter motor but also the distance between the batteries and the set (voltage drops on the line).

### 3.3.2.12 Cooling

Three types of heat production must be dissipated:

- heat from the engine cooling circuit(s)
- heat radiating from the engine and exhaust
- ventilation air from the room
- exhaust gases

The systems described below evacuate and pipe the heat produced by the engine cooling circuit.

#### a) Ventilated radiator

The engine cooling circuit is connected to a tubular ribbed radiator at the end of the frame in order to implement this procedure. This radiator is cooled by the fan controlled directly by the engine.

In all cases the air is blown in the direction from fan ⇔ radiator.

Cooling is ensured by the circulation of air across the room.

An expansion vase can compensate for the variations in the volume of coolant fluid according to the temperature.

#### b) Air recoler

The engine cooling circuit is connected to an air recoler located inside or outside the room in order to implement this procedure.

When located in the room, it operates in the same way as a ventilated radiator. The fan is either attached to the diesel engine or run by an electric motor. If the air recoler is moved outside, on the roof or in another room, the coolant pipes are extended and cooling ventilation is supplied from another room. In these installations the degassing conditions should be considered even more carefully than for a radiator.

In all cases, the air cooler is cooled by the fan.

For cooling by radiator or air cooler in the room, the increase in temperature due to heat radiation for the sizing of the installation should be taken into account.

### 2.3.9 Recommendation for the operator and environment

- Operating personnel should be aware of the safety and operating instructions. These will be regularly updated.
- Operating should be monitored, directly or indirectly, by someone designated by the operator who is familiar with the installation and dangers and problems regarding products stored and used in the installation.
- No-one from outside the establishment should be able to access the installations freely, unless designated by the operator.
- The user should check the service pressures of the different pressure stages, making sure that they are in accordance with the prescribed operating requirements. The user is also responsible for making the apparatus adjustments according to the manufacturer's instructions and should check that the apparatus is operating correctly.
- The user should create or obtain a document describing modifications and showing alterations made to the installations in relation to the original document.
- 
- Manufacturers' notes should be available to technical staff, on site if possible.
- The internal network diagram should be displayed as close as possible to the access points showing all the individual points. Internal and external network information can be contained in a single distribution diagram.
- A sign on the door identifies and gives details of the operating company and includes the telephone number for the gas supplier emergency department.
- Personnel should be aware of the layout of the premises and they should be identified on site to simplify procedures. In the event of a problem, this type of knowledge about installations is crucial when poor identification of the premises might make a situation worse.
- Written operating instructions must be available for operations that involve dangerous handling procedures and driving installations. In particular, these instructions prescribe:
  - o Operating modes
  - o Frequency of testing for safety devices and devices for handling pollution and other harmful substances generated by the installation
  - o Methods for maintenance, checking and use of adjustment equipment and safety devices.
- 
- The operator should make the necessary arrangements to satisfy site aesthetic requirements. The whole site must be kept clean and in good condition.
- The premises must be kept clean and cleaned regularly with in order to avoid piles of dangerous or pollutant material or dust that could be susceptible to catching fire or causing an explosion. The cleaning equipment must be adapted to accommodate the risks presented by such products and dust.

- The presence of dangerous or combustible materials on premises where combustion apparatus is sheltered is limited to what is required for the operation.
- The installations must be operated under the constant supervision of a qualified person. This person should periodically check that the safety devices are working properly and ensure the correct fuel supply to the combustion apparatus.
- Apart from combustion apparatus, flames in any form are prohibited. This should be displayed in bold on a sign.
- Residual water, mud and waste spray is prohibited.
- The fuels to be used should correspond to the ones in the declaration file and the specifications prescribed by the combustion apparatus manufacturer.
- The fuel is considered as being in the physical state that is introduced into the combustion chamber.
- Burning waste in the open air is prohibited.
- Except for where a specific agreement has been made, once the gas supply main unit has been closed, it can only be reopened by the gas distributor. However the user may conditionally have access to it. Check for each site.
- Always protect your hands when detecting leaks. Pressurised fluids can enter body tissues and cause severe harm. Risk of blood poisoning.
- Drain and discard engine oil in a designated container (the fuel distributors can collect your used oil).

Figure 12: silencers

These reduce noise by absorbing or causing phase differences in the sound wave. An exhaust should be effectively suspended, the supports should never rest on the set (except for original fittings). An exhaust compensator will be fitted to the engine outlet. The pipes will never have a diameter less than the set (refer to us about vermin ) and be directed so that gas cannot return to the room.

The pipes should be fixed so that their weight is not supported by the compensator. It should be perfectly straight (any misalignment could lead to a rupture).

#### "Adapted" silencer

The "adapted" silencer is fitted directly to the set or cover. It is an absorption type silencer. A compensator is fitted between the engine and exhaust in the covered version'.

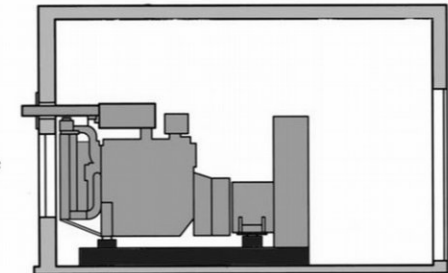

#### Absorption silencer

The gas passes through a sound proof duct made of acoustic high efficiency absorbent material protected by a perforated metal sheet.

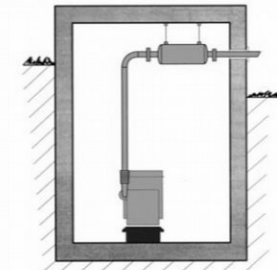

#### Absorbent reactive silencer

The gas enters an expansion chamber lined with absorbent material, supported by perforated metal sheets then into an absorbent sound proof duct.

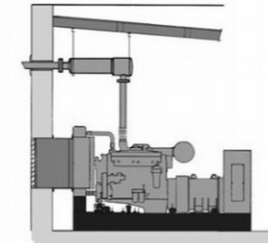

### 3.3.2.11 Electricity

#### a) Connections - general information

In the same way as for low voltage electrical installations, running and maintenance are subject to NF C 15.100 standard rules or the standards of the relevant country.

They also comply with NF C 15.401 standard rules or the standards of the relevant country.

Figure 7: suspension line  
Generally made up of a flat iron ring attached to the ceiling. The suspension line enables the pipes to expand freely.

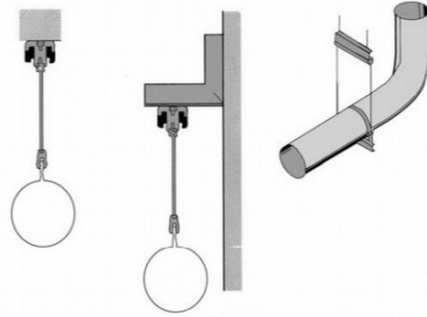

Figure 8: needle frame  
Used for vertical sections, the needle frame allows the pipes to expand while holding them laterally.

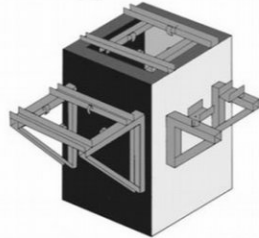

Figure 9: column base  
The column base is designed to hold the weight of the vertical pipes.

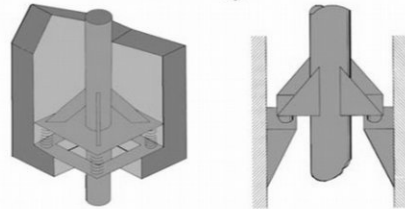

Figure 10: silencer suspension line  
The silencer suspension lines are designed to hold the weight of the silencers, they can be vertical or horizontal.

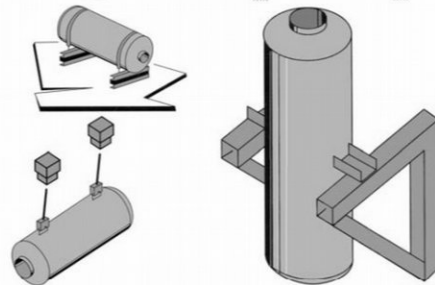

Figure 11: heat insulation  
Depending on the type of installation, you may have to insulate the heat released in the room. Once it has been insulated, the surface temperature should not exceed 70 °C. The recommended material is rock wool (excluding asbestos) and eventually it can be recovered with aluminium sheets to improve the look of the installation and the thermal insulation. 50 mm thick glass wool should be considered a minimum requirement.

### 3. INSTALLATION

#### WARNING

Sections 3, 4 and 5 contain only general recommendations. It is recommended that you use a professional to ensure correct installation and start-up. The company cannot be held responsible for breakdowns related to the conditions of installation.

#### 3.1. Unloading

##### 3.1.1 Safety during unloading

In order to unload generating sets from their transport mountings, under optimum conditions of safety and efficiency, you should check that the following points are being followed correctly.

- Suitable lifting vehicles or equipment for the work.
  - Slings positioned in the rings provided for this procedure or lifting arms resting fully underneath the frame cross beams.
  - Suitable ground to accommodate the load of the set and lifting vehicle, without strain (if not, put down sufficiently strong and stable boards).
- Remove the set as close as possible to its place of use or transport, in a clear space with free access.

##### 3.1.2 Example of material

- crane, slings, lifting beam, safety hook, shackles.
- fork lift truck.

##### 3.1.3 Instructions for unloading

###### 3.1.3.1 Slings

- attach the lifting vehicle slings to the rings on the generating set designed for this procedure.
- hang the slings carefully.
- check that the slings are correctly attached and the equipment is solid.
- lift the generating set carefully.
- direct and stabilise the set towards the chosen position.
- carefully set down the equipment while continuing to position it.
- release the slings, then detach and remove the lifting rings.

Warning: The slings must be perpendicular to the frame in order not to interfere with the set (no rubbing).

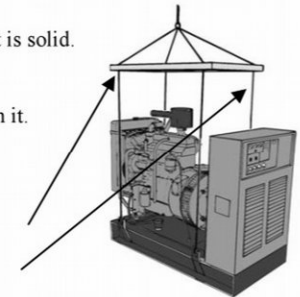

### 3.1.3.2 Fork lift truck

- position the arms of the fork lift under the frame, making sure that only the cross beams are resting on the arms.
- lift and handle the equipment carefully.
- set down the generating set in its unloading position.

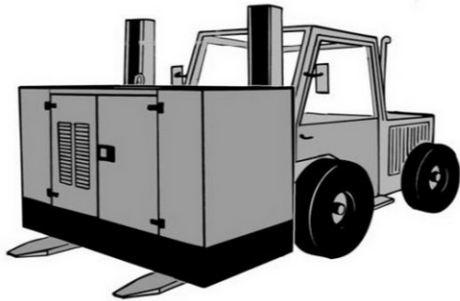

### 3.2 Handling instructions

- carefully lift the edge on the engine side with 2 jacks then slide 3 pipes under the frame
- leave the frame under the pipes then move the set by pushing manually.
- while the set is being moved, use the freed pipes by sliding them one after another under the frame.
- when it has reached the desired location, position the set then lift it up using jacks to support it.
- remove the pipes and put down the set checking that it is in the correct position, then remove the jacks.

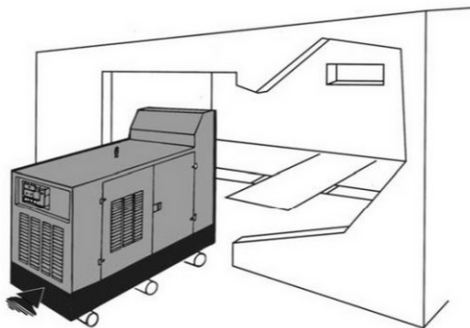

### Figure 1 : Pipes

It is recommended that you use seamless pipes. However, for weight reasons, rolled steel pipes can be used. In any event, welded "bars" inside the duct are to be avoided.

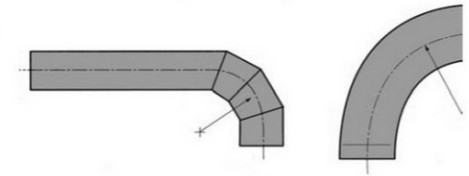

### Figure 2: elbows

The elbow should have a minimum curve radius of  $2D$  if possible in a single component. If the elbow is made of welded steel, check that it includes at least 3 sectors for  $90^\circ$  elbows.

### Figure 3: expansion bellows and hoses

- expansion bellow : absorbs sideways movements due to expansion (approx  $1\text{mm}/\text{metre}/100^\circ\text{C}$ ).
- hose: allows for considerable sideways travel, but low longitudinal amplitude.



### Figure 4 : condensation and rainwater bleed

Allowed for in the lower section of the installation, to protect the silencer and engine or for any changes in horizontal/vertical travel.

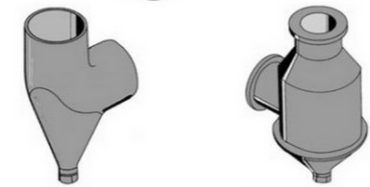

### Figure 5 : bulkhead crossing - roof outlet

For each bulkhead passage and roof outlet.

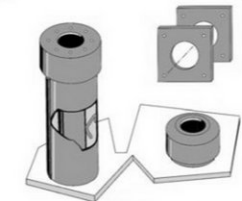

### Figure 6: exhaust outlet

The exhaust outlets disperse the gases in the atmosphere and protect the inner section of the pipes from bad weather.

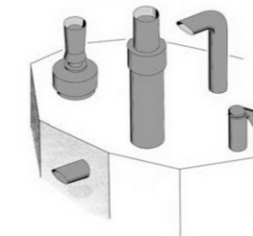

### 3.3.2.10 Burnt gas exhaust

Studying the evacuation of burnt gases by a generating set should not be seen as a minor detail due to the fact that a pipe can always be installed, even in the most inaccessible areas. In fact, there are a certain number of constraints to be considered such as drops in pressure caused by the exhaust, insulation, suspension, noise level and air pollution. It should be noted that the more complicated a circuit, the more it causes drops in pressure and consequently, its diameter will be large and heavy and its supports and silencers expensive.

**NOTE**  
generating sets with a silencer fitted in the enclosure must be fitted with an exhaust compensator. This compensator or hose will be fitted to the exhaust outlet in the cover.

#### Main components

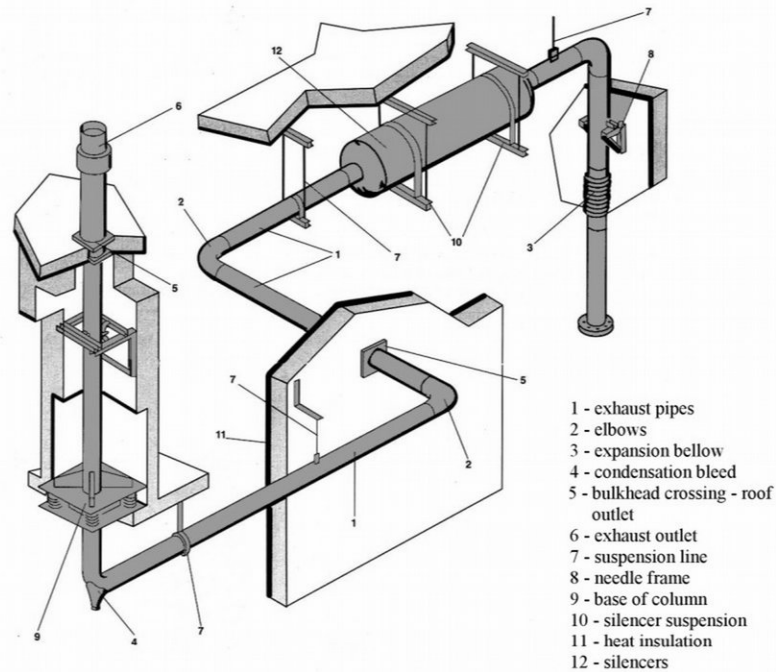

- 1 - exhaust pipes
- 2 - elbows
- 3 - expansion bellow
- 4 - condensation bleed
- 5 - bulkhead crossing - roof outlet
- 6 - exhaust outlet
- 7 - suspension line
- 8 - needle frame
- 9 - base of column
- 10 - silencer suspension
- 11 - heat insulation
- 12 - silencers

The installer must check that all the components installed on the exhaust pipe do not cause pressure drops greater than the engine's admissible pressure.

It is recommended to use a fork lift truck with arms that are longer than the width of the frame

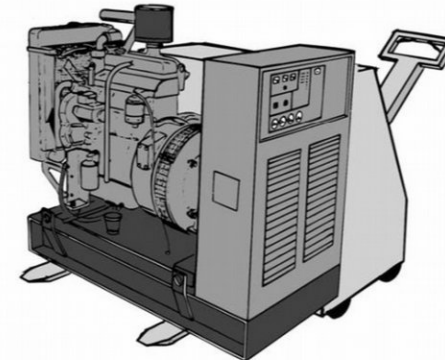

If you are using a rail or crab once it is in position, continue in the same way as described in the "slings" paragraph

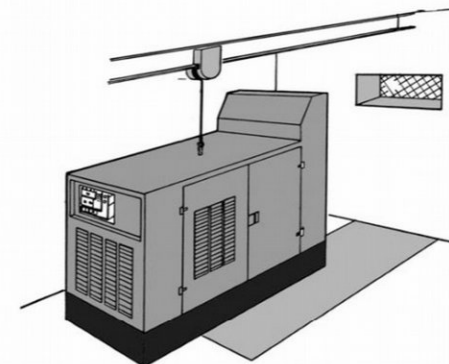

### 3.3 Installation of fixed sets

#### NOTE

If you do not follow the basic principles, the installation assembly will suffer damage and abnormal wear. The procedure described gives the main requirements for installing a "conventional" generating set made up of a heat engine, a generator and electric panel. These requirements are general principles to be observed. For any specific applications or if you have any doubts, our technical departments will advise you and look at your specific conditions of installation. The current regulations, provisions and laws in installation locations must be adhered to.

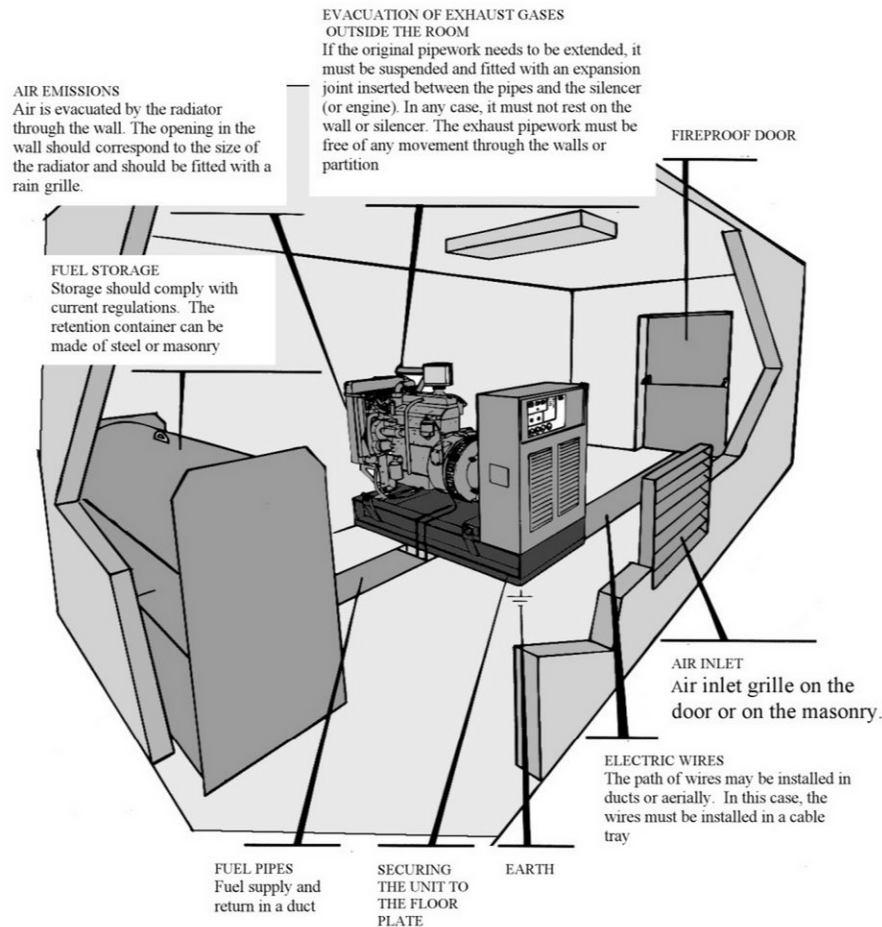

### 3.3.2.9 Fuel

Since the fuel is classed as a "dangerous product", certain regulations for storage and distribution must be followed. It is also necessary to consult current laws when carrying out the installation.

It is usual to fit fixed installations with a daily service tank and storage tank. These two tanks can be joined into one if the generating set consumption is low.

#### WARNING

Do not use galvanised receptacles or brass coated receptacles for storing fuel.

#### a) Manual filling tank

Solution for a manual starting generating set that is visually monitored. This tank is often part of the frame and has a mechanical gauge, filler neck and drain port.

#### b) Automatic filling tank located in the room

Solution for automatic starting generating sets. The tank is automatically filled by an electric drawing pump in a main storage tank.

This type of installation is subject to regulations. Moreover, it should be fitted with a retention container capable of collecting leaks with a capacity at least equal to that of the tank. There must be an overflow pipe going back to the main tank. Its section should be at least twice that of the supply pipes.

To prevent unpriming, the tank is fitted slightly filled in relation to the diesel engine (except in covered parking areas).

This tank must also be fitted with a shut-off valve for which the control must be located outside the room.

- 1 - Double lined storage tank
- 2 - Leak testing cell
- 3 - Filling port
- 4 - Shut-off valve control unit
- 5 - Safety valve control unit
- 6 - 600 L retention container
- 7 - 500 L daily service tank
- 8 - Gauge with level switch
- 9 - Manual pump
- 10 - Electric pump
- 11 - generating set
- 12 - Vent
- 13 - Safety valve
- 14 - Shut-off valve
- 15 - Earthing
- 16 - Electric fuel level gauge
- 17 - Anti-return valve with strainer
- 18 - Concrete floor plate
- 19 - Anchoring belt (1/m)
- 20 - Pits
- 21 - Pipe passage
- 22 - Access plug
- 23 - Drains
- 24 - Min hole: 0.70 x 0.70
- 25 - Type and capacity label

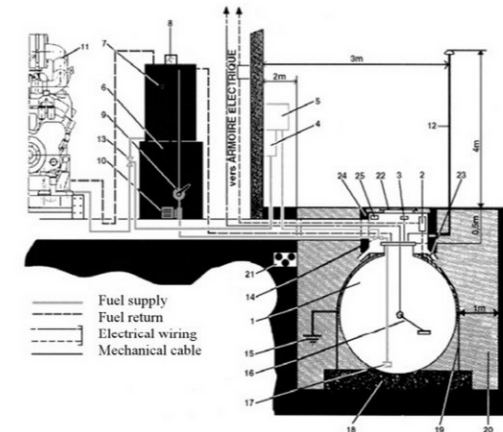

Example of installation

### General arrangements

- building structure made from framing concrete or solid concrete blocks, 20 cm thick minimum
- anti-vibrating floor plate under the generating set when adjoining sensitive areas.
- ceiling and walls covered if necessary with absorbent materials
- choice of adapted exhaust silencer(s).
- soundproofed door for access to the room and, if required, to the pressure lock, for a very low sound level.
- sound traps fitted to the air inlet and outlet sleeves.

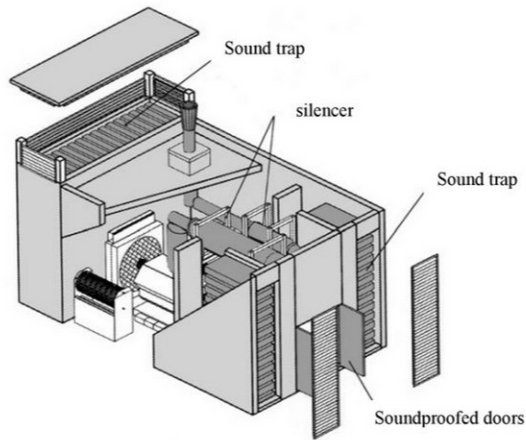

Example of installation

### 3.3.2.8 Ventilation

A heat engine generates a certain amount of heat, which must be evacuated outside the room to ensure the set works properly.

The heat released by the set originates from different sources:

- cylinder cooling
- radiation from the engine unit and exhaust duct
- alternator cooling.

Also the room must be fitted with air inlet and outlet openings suitable for the conditions of use and cooling system. As you know, insufficient ventilation will cause the atmospheric temperature to rise and lead to problems ranging from, at least, a loss of engine power to the set stopping altogether.

Air must flow through the set room from alternator ⇔ engine ⇔ radiator.

This solution also supplies the quantity of fresh air needed for combustion. The openings should be of ample size.

Air intake and emission will be as direct as possible. The cooling system will be connected to a sealed emission sleeve or cover to prevent hot air from being recycled. The air inlet and emission openings should not be located close to one another.

### 3.3.1 Position

It should be determined on the basis of use. There are no specific rules governing the choice of location, other than proximity to the electric distribution panel and disturbances caused by the noise. However, fuel supply, burnt gas evacuation, and the direction of these gases and the noises emitted should be taken into account.

The choice of its position will be based on carefully considered compromise!

Examples of problems that may be encountered:

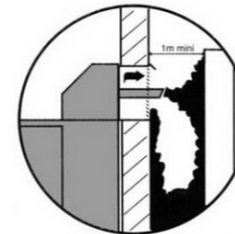

Incorrect exhaust and ventilation



Ground too uneven or soft.  
Set incorrectly positioned

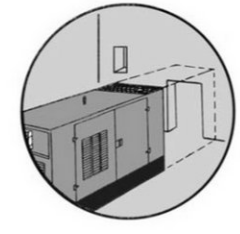

Reduced access

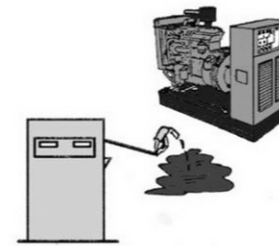

Fuel filling impossible

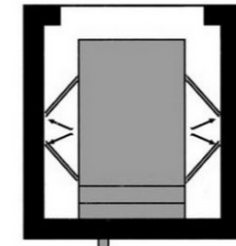

Opening cover doors impossible

### 3.3.2 Measurements and layout

These are governed by two types of requirement:

#### 3.3.2.1 Static requirements

These are the dimensions of the equipment installed and its surroundings, namely: daily service fuel tank, cabinet, silencer, batteries etc.

### 3.3.2.2 Dynamic requirements

These are the measurements to be adhered to between each piece of equipment to allow for refitting and possible removal.

About a 1 metre space around the set is considered the minimum required for carrying out problem-free maintenance. This will give enough space to check that the doors of covered sets open fully, that equipment can be accessed for maintenance and that integral removal of the set can be carried out.

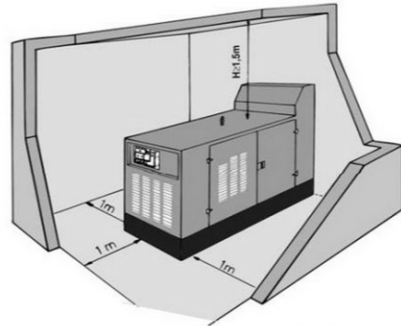

Example of room dimensions for a covered version set.

### 3.3.2.3 Construction

All sorts of shelters can be designed to house a generating set.

If noise level and speed of starting are not the main considerations in your choice, it can be installed under a basic shelter to protect it from bad weather (rain, snow, storms, etc.).

If a low noise level and fast start are important criteria, (e.g.: emergency set or noise sensitive area), particular attention will be given and the room will be built of framing concrete or solid concrete blocks 20 cm minimum, covered in absorbent fireproof and insulating material.

#### NOTE

The fire test should comply with current legislation according to the type of building.

### 3.3.2.4 Base of the set

An operating generating set generates a certain amount of vibratory energy. This vibratory energy makes its way to the floor plate via the frame. As a rule, our generating sets do not require a specific floor plate as they are fitted to elastic mountings. However, the floor plate will be sufficiently strong and detached from the rest of the construction. It will also be level, smoothed by the flow and unshackled.

If there is a risk of vibrations being transmitted, the set can be mounted on a vibration-mounted floor plate insulated if necessary by a resilient material.

This solution is mainly used with very powerful generating sets.

### 3.3.2.5 Openings

The room should include a certain number of openings which are required for it to operate:

- a door, giving access to the generating set and its accessories, preferably in line with the set's floor plate
- ventilation openings (fresh air inlet and hot air outlet) located so that scavenging takes place in the direction from the alternator towards the engine. Their surfaces depend on the power of the generating set being installed, general atmospheric conditions, the cooling system selected and the soundproofing procedure.

### 3.3.2.6 Lifting

The lifting system should usually be an integral part of the construction. It is made up of an H or I steel rail, embedded in the walls and ceiling, and a crab. It should be easy to handle and is generally used on top along the longitudinal axis of the set and directed towards the exit.

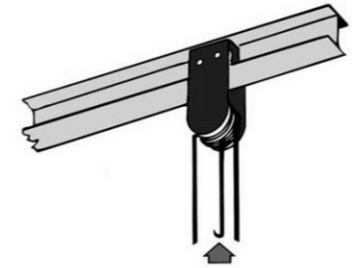

### 3.3.2.7 Soundproofing

The room is soundproofed using two procedures:

Insulation:

This prevents the noise from crossing the walls, and in this case, it is the weight then thickness of the wall that is important.

Absorption:

These are materials that absorb sound energy and this procedure will be used on ventilation openings. As a result of this, the air inlet and outlet sections are increased.

The internal lining of the room can also be covered with absorbent material designed to lower the sound level in the room, and consequently through the walls, ventilation openings and door.